

DIMENSIONS (mm)

Width: 1187/1274/1741/2061

Depth: 1270/1319

Height: 970/1000

Width of passage: 530/600/765/900

Glass height: 915/920/1700

CONSTRUCTION

Standard finish in stainless steel, other options are available

FLOW RATE

16 people per min / 3.75 sec per cycle

Did you know?

Most suppliers quote a machine value flow rate as opposed to a practical one. We provide honest and achievable flow rates.

SPEED GATES

Safetell's Speed Gates provide a sleek entrance control and anti-tailgating solution to a building or secure area. Typical applications include airports, authorised personnel entry points, government buildings, corporate buildings, museums, theatres, arenas, stadiums, leisure centres and gyms.

MAIN FEATURES

- Easy setup – easy configuration of operation modes and functions via the touch panel
- LED pictograms – shows active/inactive traffic directions in the passage, the red arrow shows the inactive/blocked traffic direction and the green arrow shows the active/unblocked traffic direction
- Sound signalling – an alarm sounds in unusual situations e.g. two people trying to pass through, unauthorised access or an unauthorised object in the movement detection area
- Emergency exit – the gate remains open in case of a power failure
- Overload protection – all gates have additional overload protection systems to stop the wings and sound the alarm if an obstacle is detected
- Sensor array – system software analyses sensor signals to detect two people trying to pass through at once, or a person passing without authorisation

OPTIONAL

- Available in different sizes and styles
- Glazing colour options include clear, dark grey, dark blue, bronze
- Finish options include Inox, Galvanised, Galvanised + RAL, RAL 5010, RAL 9003, RAL 7016



SERVICE &
MAINTENANCE
AVAILABLE

+44 (0) 1322 223 233

sales@safetell.co.uk

safetell.co.uk

TECHNICAL DRAWINGS

STANDARD LANE
HALF HEIGHT GLASS

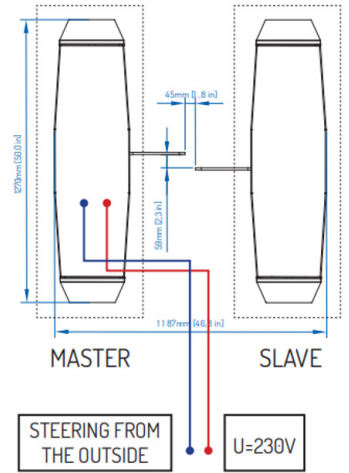
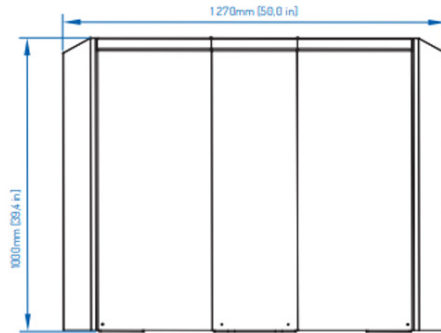
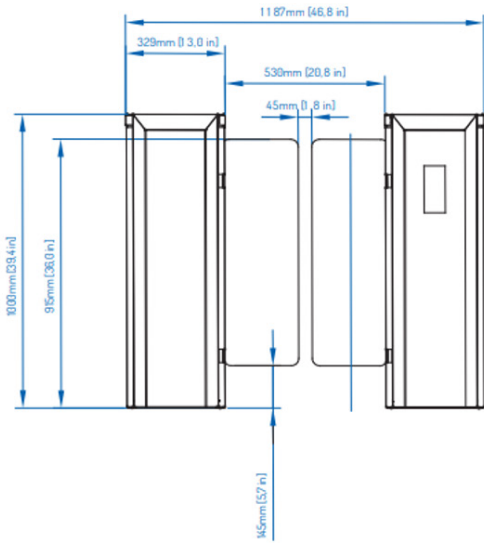

STANDARD LANE
FULL HEIGHT GLASS

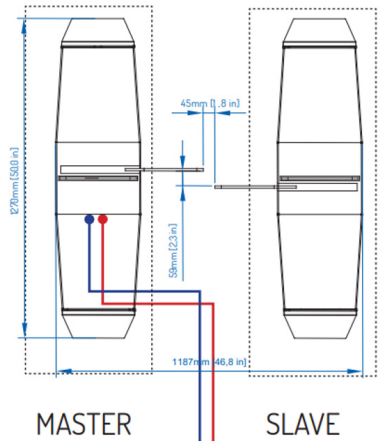
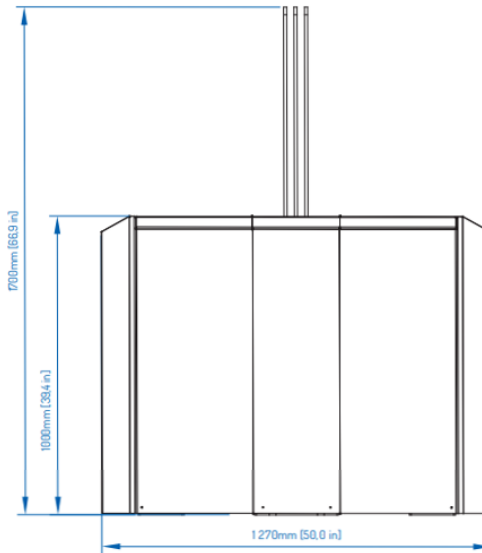
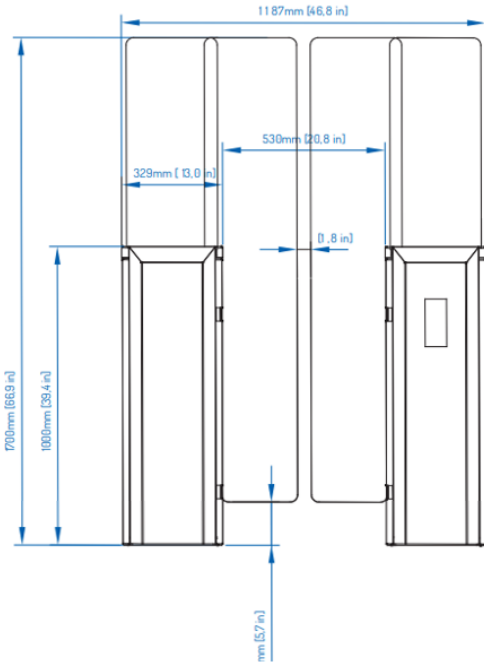

WIDE LANE
HALF HEIGHT GLASS

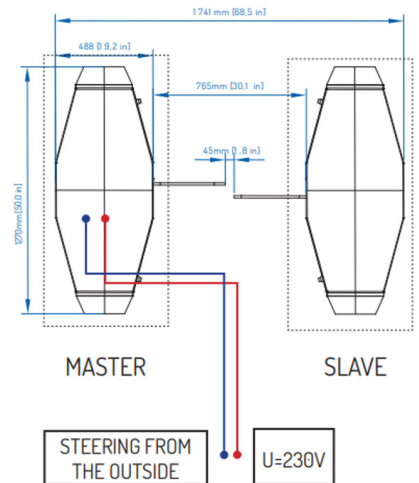
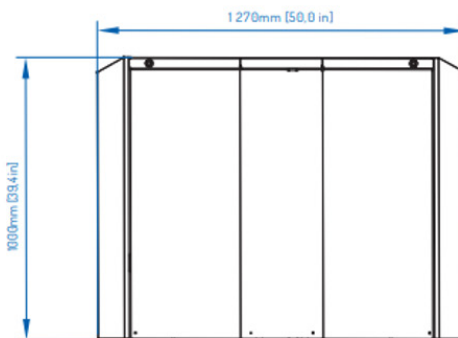
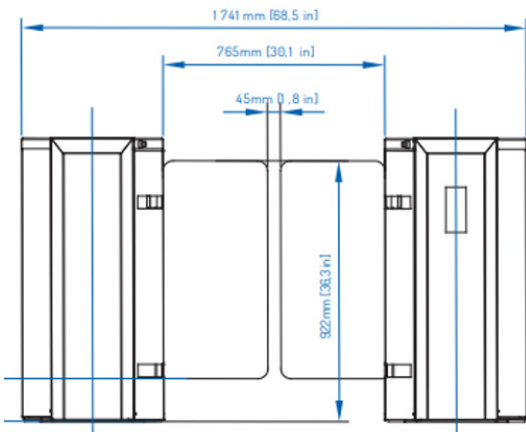

TECHNICAL DRAWINGS

WIDE LANE
FULL HEIGHT GLASS

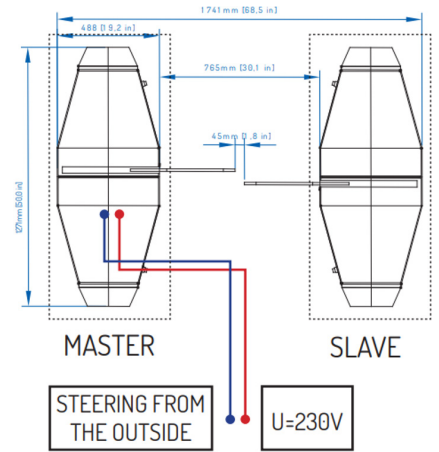
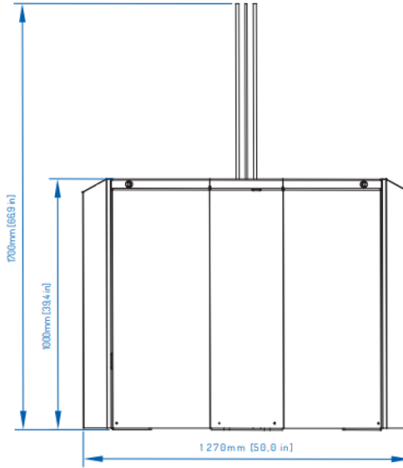
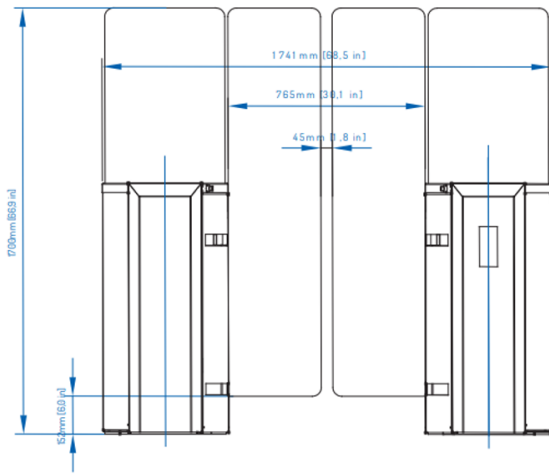

DDA LANE
HALF HEIGHT GLASS

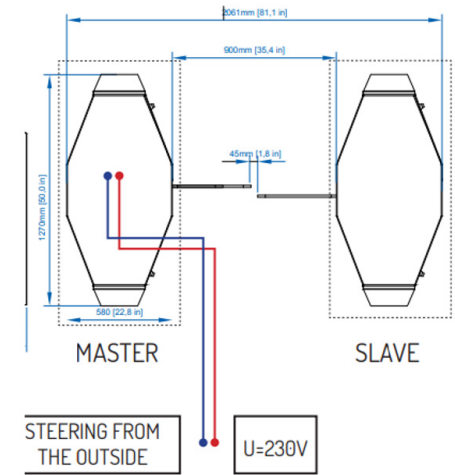
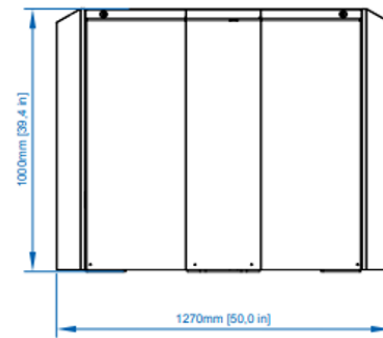
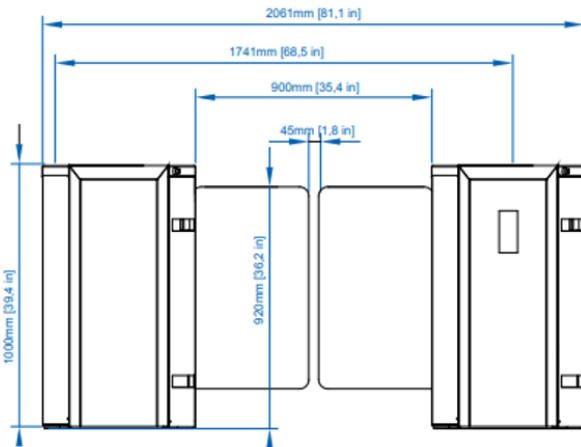

DDA LANE
FULL HEIGHT GLASS

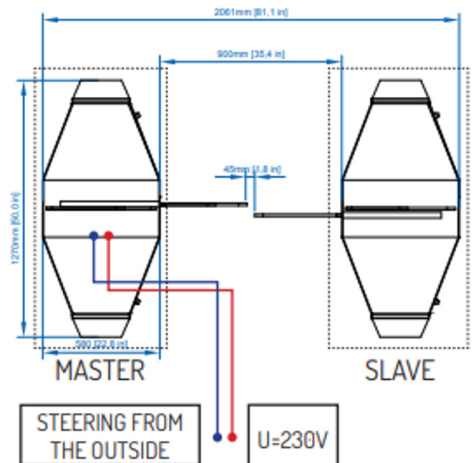
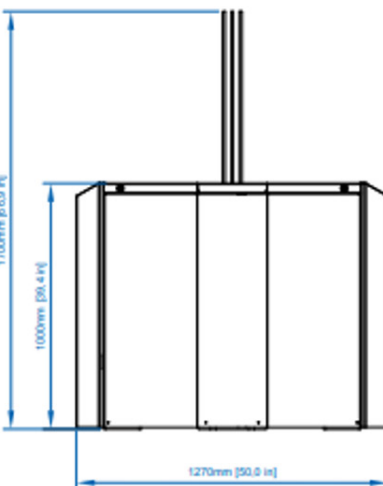
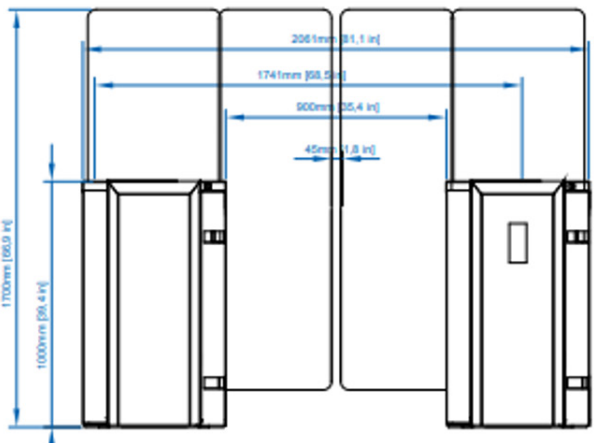

FINISHES



CLEAR

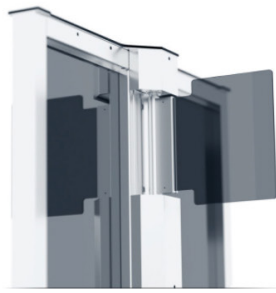

DARK GREY



DARK BLUE



BRONZE



INOX



GALVANISED

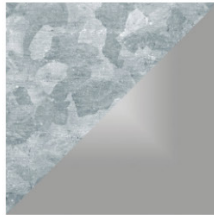

GALVANISED + RAL



RAL 5010



RAL 9003



RAL 7016



HALF HEIGHT GLASS
Glass Height = 915mm
Width of Passage = 530 or 765mm



FULL HEIGHT GLASS
Glass Height = 1700mm
Width of Passage = 530 or 765mm



HALF HEIGHT GLASS DDA
Glass Height = 920mm
Width of Passage = 900mm



FULL HEIGHT GLASS DDA
Glass Height = 1700mm
Width of Passage = 900mm



COMPACT CAB
Height = 970mm
Width of Passage = 600mm

WE ARE FULLY ACCREDITED



+44 (0) 1322 223 233

